

UNITED STATES
SECURITIES AND EXCHANGE COMMISSION

Washington, D.C. 20549

FORM 8-K
Current Report

Pursuant to Section 13 or 15(d) of the Securities Exchange Act of 1934

Date of Report (date of earliest event reported): June 5, 2017

LION BIOTECHNOLOGIES, INC.
(Exact Name of Registrant as Specified in Charter)

Delaware
(State of Incorporation)

000-53127

Commission File Number

75-3254381

(I.R.S. Employer Identification No.)

999 Skyway Road, Suite 150
San Carlos, California

(Address of Principal Executive Offices)

94070

(Zip Code)

(650) 260-7120

(Registrant's Telephone Number, Including Area Code)

Check the appropriate box below if the Form 8-K filing is intended to simultaneously satisfy the filing obligation of the registrant under any of the following provisions:

- Written communications pursuant to Rule 425 under the Securities Act (17 CFR 230.425).
- Soliciting material pursuant to Rule 14a-12 under the Exchange Act (17 CFR 240.14a-12).
- Pre-commencement communications pursuant to Rule 14d-2(b) under the Exchange Act (17 CFR 240.14d-2(b)).
- Pre-commencement communications pursuant to Rule 13e-4(c) under the Exchange Act (17 CFR 240.13e-4(c)).

Indicate by check mark whether the registrant is an emerging growth company as defined in Rule 405 of the Securities Act of 1933 (§230.405 of this chapter) or Rule 12b-2 of the Securities Exchange Act of 1934 (§240.12b-2 of this chapter).

Emerging growth company

- If an emerging growth company, indicate by check mark if the registrant has elected not to use the extended transition period for complying with any new or revised financial accounting standards provided pursuant to Section 13(a) of the Exchange Act.

Item 7.01. Regulation FD Disclosure.

Lion Biotechnologies, Inc. (the "Company") from time to time makes presentations to analysts, current stockholders and others. A copy of the Company's presentation is furnished as Exhibit 99.1 to this current report on Form 8-K and incorporated under this Item 7.01 by reference.

The information contained in this Item 7.01, including Exhibit 99.1, shall not be deemed "filed" for any purpose, and shall not be deemed incorporated by reference to any filing under the Securities Act of 1933, as amended, or the Securities Exchange Act of 1934, as amended, regardless of any general incorporation language in any such filing.

Item 9.01 Financial Statements And Exhibits

(d) Exhibits

Exhibit No.	Description
99.1	Lion Biotechnologies, Inc., Corporate Presentation.

SIGNATURES

Pursuant to the requirements of the Securities Exchange Act of 1934, the Registrant has duly caused this Report to be signed on its behalf by the undersigned hereunto duly authorized.

Date: June 5, 2017

LION BIOTECHNOLOGIES, INC.

By: /s/ MARIA FARDIS
Maria Fardis, Chief Executive Officer



LEADERSHIP & INNOVATION IN ONCOLOGY

Corporate Presentation

June 2017

© 2017, Lion Biotechnologies

Forward-Looking Statements

This presentation contains forward-looking statements reflecting management's current beliefs and expectations. These forward looking statements can be identified with words such as "expects", "plans", "projects", "potential", "suggests", "may", or similar expressions. Such forward-looking statements involve known and unknown risks, uncertainties and other factors that may cause the actual results to be materially different from any future results, performance or achievements expressed or implied by such statements. Forward-looking statements in this presentation include statements regarding (i) the success and timing of our product development activities and clinical trials, (ii) our ability, and the ability of our commercial partners, to manufacture, process and deliver our product candidates and to further improve on the manufacturing process, (iii) the size of the potential markets for our product candidates, (iv) our ability to develop next generation TIL and other more effective and efficient therapeutics, (v) our ability to maintain our collaborations and other relationships with third parties, including in particular with the National Cancer Institute/NIH, (vi) our ability to attract and retain key management and scientific personnel, (vii) our ability to obtain and maintain intellectual property protection for our product candidates, (viii) our ability to compete with other therapeutics that target the same indications as our product candidates, and (ix) our ability to achieve our manufacturing, clinical, regulatory, and other key milestones.

For more detailed information about the risks and uncertainties that could cause actual results to differ materially from those implied by, or anticipated in, these forward-looking statements, please refer to the Risk Factors section of the Company's Annual Report on Form 10-K and subsequent updates that may be contained in the Company's Quarterly Reports on Form 10-Q and current reports on Form 8-K on file with the SEC. Forward-looking statements speak only as to the date they are made. Except as required by law, the Company does not undertake to update forward-looking statements to reflect circumstances or events that occur after the date the forward looking statements are made. This presentation does not constitute an offer to sell or buy securities, and no offer or sale will be made in any state or jurisdiction in which such offer or sale would be unlawful prior to registration or qualification under the securities laws of any such state or jurisdiction.

Corporate Highlights

- **Clinical-stage biotechnology company** focused on the development and commercialization of tumor infiltrating lymphocyte (TIL) therapy for cancer patients
- **Leveraging and enhancing the utility of TIL therapy** as demonstrated by Dr. Steven Rosenberg at the NCI
 - 56% ORR and a 24% CR rate in 101 metastatic melanoma patients, durable responses
- Lion has **Orphan Drug Designation for its TIL product (LN-144) in metastatic melanoma**
 - Phase 2 trial of LN-144 is ongoing and has been expanded to 3 cohorts
 - Data for cohort 1 recently presented at ASCO: responses seen in heavily pre-treated patients
- TIL therapy is also being evaluated by Lion or its collaborators in **ongoing or planned trials in other solid tumors** including: cervical, head and neck, ovarian, sarcomas, pancreatic cancer, and glioblastoma
- Lion has **several TIL collaborations and partnerships** with NIH/NCI, Moffitt Cancer Center, Karolinska Institute/PolyBioCept, MD Anderson Cancer Center and MedImmune/AstraZeneca,
- Collaborations with manufacturing CMOs including Wuxi AppTec, Lonza and Moffitt Cancer Center in US and PharmaCell in EU provide expanded **TIL manufacturing capacity**
- **Management team** has extensive drug development and cell therapy experience

TIL Therapy Process

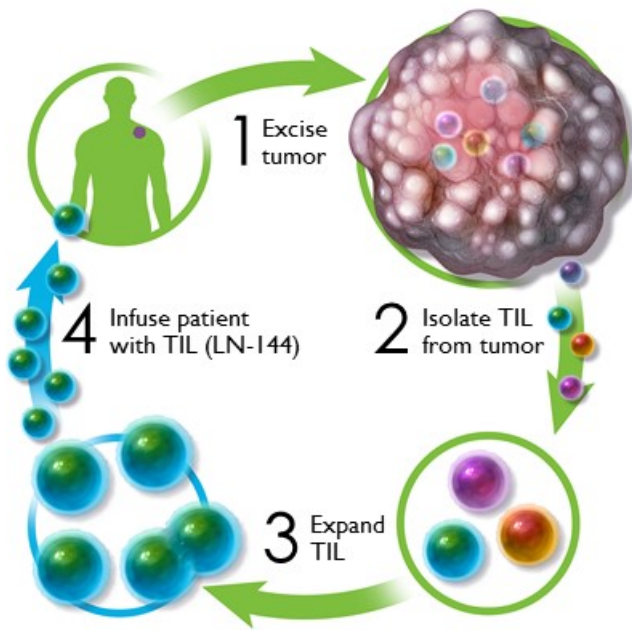

EXTRACTION: Patient's TIL are removed from suppressive tumor microenvironment (via surgical resection of a lesion)

EXPANSION: TIL expanded exponentially *ex vivo* to yield $10^9 - 10^{11}$ TIL

PREPARATION: Patient receives non-myeloablative lymphodepletion, to eliminate potentially suppressive tumor microenvironment and maximize engraftment and potency of TIL therapy:













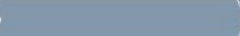
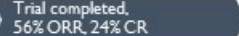

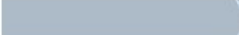

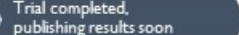

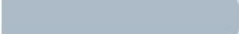



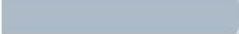

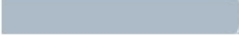

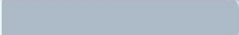

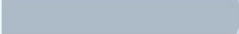
- cyclophosphamide: 60 mg/kg, x 2 doses
- fludarabine: 25 mg/m² x 5 doses

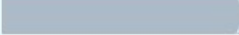
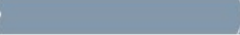
INFUSION: Patient is infused with their expanded TIL (LN-144) and IL-2 (600,000 IU/kg for up to 6 doses) to promote activation, proliferation, and anti-tumor cytolytic activity of TIL

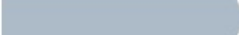
© 2017, Lion Biotechnologies

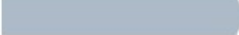
LION
BIOTECHNOLOGIES

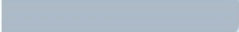
Lion Biotechnologies Pipeline

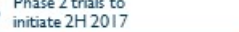
INDICATION	REGIMEN	N	PARTNER	PRECLINICAL	PHASE I	PHASE 2
Melanoma	Combination TIL ± TBI	101				
Melanoma	Combination TIL + ipi					
Melanoma	Combination TIL + Keytruda	170				
Melanoma	Combination TIL + Opdivo	12				
Ocular (Uveal) Melanoma	TIL	23				
Melanoma	TIL LN-144	60	—			
Cervical Cancer	TIL LN-145	47	—			
Head & Neck Cancer	TIL LN-145	47	—			
Glioblastoma	TIL					
Pancreatic Cancer	TIL					
Ovarian, Sarcomas, Pancreatic	TIL					

Key Collaborations and Partnerships

National Cancer Institute/NIH

- Cooperative Research And Development Agreement (CRADA) with Dr. Steve Rosenberg Development of TIL for metastatic melanoma, bladder, lung, breast, and HPV-associated cancers and combination therapies
- TIL + PD-I combination clinical trial to treat melanoma



MedImmune/AstraZeneca

- TIL + PD-L1 combination clinical trial



Moffitt Cancer Center

- TIL + Checkpoint inhibitor combination clinical trial to treat metastatic melanoma



Karolinska Institute/ PolyBioCept

- TIL clinical trials to treat glioblastoma and pancreatic cancer



MD Anderson

- TIL clinical trials to treat Ovarian, Sarcomas, and pancreatic cancers



A microscopic image showing a dense population of Tumor Infiltrating Lymphocytes (TILs). The cells are stained and appear as various shapes, including elongated and rounded forms, against a teal background. The text "TIL Therapy" is overlaid in white.

TIL Therapy

TIL Therapy: Elicits a Highly Individualized, Specific, and Potent Attack Against Solid Tumors

- Leverages and enhances the body's natural defense against cancer using a patient's own TIL
- Polyclonal and can recognize multiple neoantigens
 - Solid tumors are heterogeneous
- Durable response with one-time treatment
 - Potential to establish immunological memory, requiring no additional maintenance therapy after infusion
- Responses seen both in treatment naïve and refractory melanoma patients who have failed other options, including checkpoint inhibitors

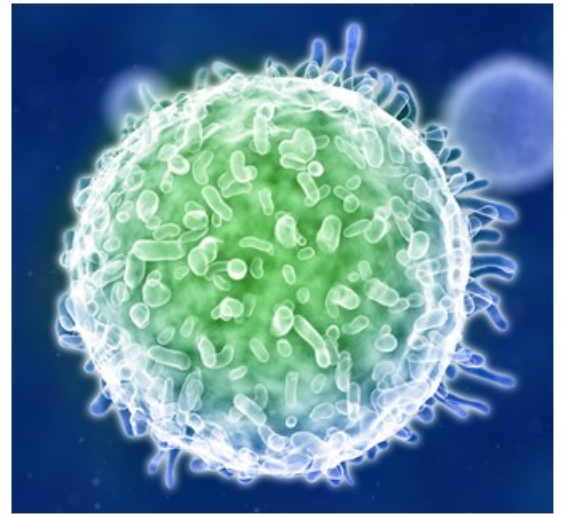

Lion Manufacturing Process & Logistics

Gen 1 Duration: ~5-6 Weeks

Gen 2 Duration: ~3.5 Weeks Cryopreserved Product

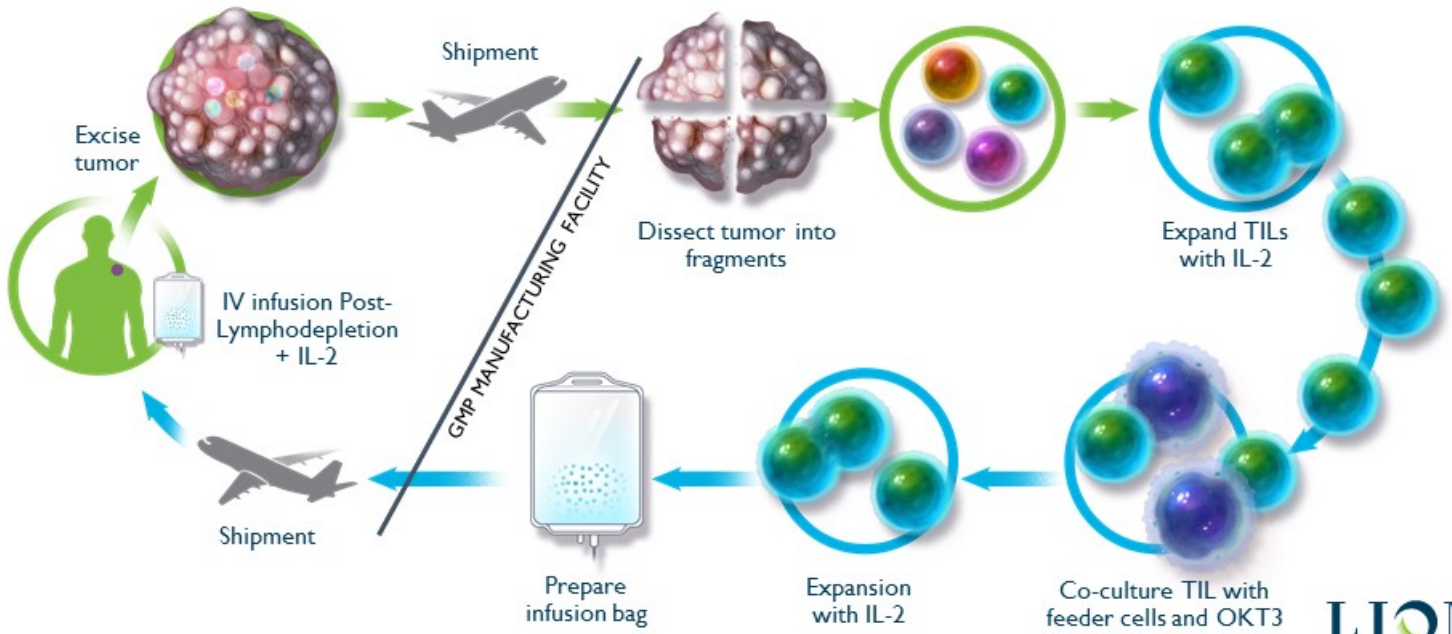

© 2017, Lion Biotechnologies

LION
BIOTECHNOLOGIES

Manufacturing Capacity

Adequate Capacity to Support a Broad Clinical Plan

- Lion's Manufacturing process is centralized at the following CMO sites:

- Lonza, Walkersville
- Wuxi AppTech
- Moffitt as CMO
- PharmaCell (EU)

- Lion developed the Gen 1 process through modification of the NCI's TIL manufacturing method. **Gen 2 and all manufacturing SOPs were developed by Lion.**

- Lion has certain IP rights relating to the method of manufacturing used by Polybiocept (PBC) and MDA

#	INDICATIONS	LION BIOTECHNOLOGIES GENERATION		polybiocept	MDAnderson Cancer Network
		1	2	IL-2, 15, 21	41BB
1	Melanoma	Lonza	Moffitt		
2	Cervical	Wuxi			
3	Head and Neck	Wuxi			
4	Pt Resistant Ovarian	Wuxi			MDA
5	Chondrosarcoma	Wuxi			MDA
6	Soft tissue sarcoma	Wuxi			
	Pancreatic ductal carcinoma				MDA
	GBM			PBC	
	Pancreatic			PBC	

Melanoma

NCI Study with TIL Therapy in Melanoma

- Data from randomized Phase 2 trial in 101 patients with metastatic melanoma at the NCI confirmed TIL treatment was associated with high, durable objective response rates, including patients that were refractory to checkpoint inhibitors:⁽¹⁾
 - Patient population enrolled, was broad
 - CRs rate: 24% of patients, 23/24 complete responders showed durability of 30-47 months
 - Overall response rate was 56%
 - Overall survival was ~80% at 12 months; median not yet achieved
- Complete response rate of 29% reported in 34 patients that had failed either anti-CTLA-4 **or** anti-PD-1
 - Overall response rate was 36% for patients who had progressed through anti-PD-1 therapy (4/11 responded)
 - Overall response rate was 25% for patients who had progress through **both** anti-PD-1 and anti-CTLA-4 (2/8 responded)

⁽¹⁾ Goff, S.L. et al. Randomized, Prospective Evaluation Comparing Intensity of Lymphodepletion Before Adoptive Transfer of Tumor-Infiltrating Lymphocytes for Patients With Metastatic Melanoma. *Journal of Clinical Oncology*, 34(20), 2389-2397.

NCI Study Treatment-Related Toxicities

ADVERSE EVENT	NMA (N=51)	TBI (N=50)
Grade 3 and 4 toxicities		
Febrile neutropenia	25	36
Bacteremia	13	5
Urinary tract infection	0	2
Atrial fibrillation	2	3
Thrombotic microangiopathy	0	13
ICU transfer on index admission		
Planned observation	0	2
Cytokine-related symptoms	0	6
Sepsis	2	1
Cardiac arrhythmia	2	3
Treatment related death	0	1

The toxicities of treatment were largely associated with the known side effects of nonmyeloablative chemotherapy (NMA) or total body irradiation (TBI) and administration of high dose IL-2⁽¹⁾

⁽¹⁾ Goff, S.L. et al. Randomized, Prospective Evaluation Comparing Intensity of Lymphodepletion Before Adoptive Transfer of Tumor-Infiltrating Lymphocytes for Patients With Metastatic Melanoma. *Journal of Clinical Oncology*, 34(20), 2389-2397.

NCI Study Survival in Melanoma

Overall Survival of patients in TIL ± TBI study

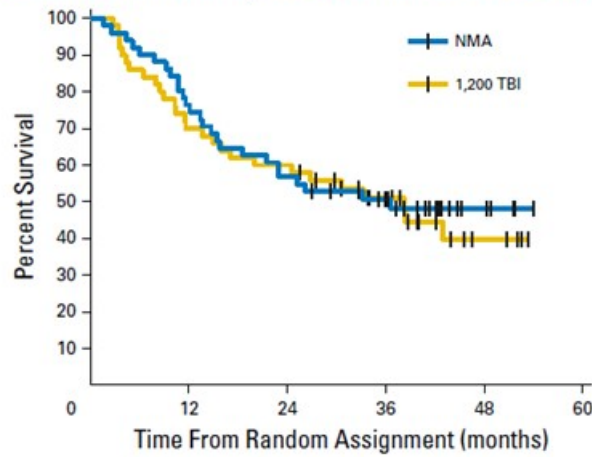

No. at risk

NMA	51	39	30	21	6	0
1,200 TBI	50	35	30	18	4	0

Goff, S.L. et al. Randomized, Prospective Evaluation Comparing Intensity of Lymphodepletion Before Adoptive Transfer of Tumor-Infiltrating Lymphocytes for Patients With Metastatic Melanoma. *Journal of Clinical Oncology*, 34(20), 2389-2397.

© 2017, Lion Biotechnologies

NCI Study Melanoma Patient

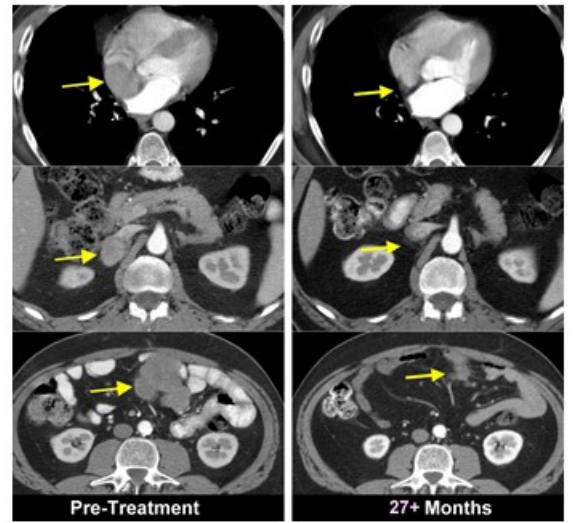

Rosenberg, et al. Adoptive cell therapy for the treatment of patients with metastatic melanoma *Curr Opin Immunol*, 21(2), 233-240.

NCI Study Survival Benefit in Second and Third Line Patients

Durable remissions in melanoma regardless of prior therapies

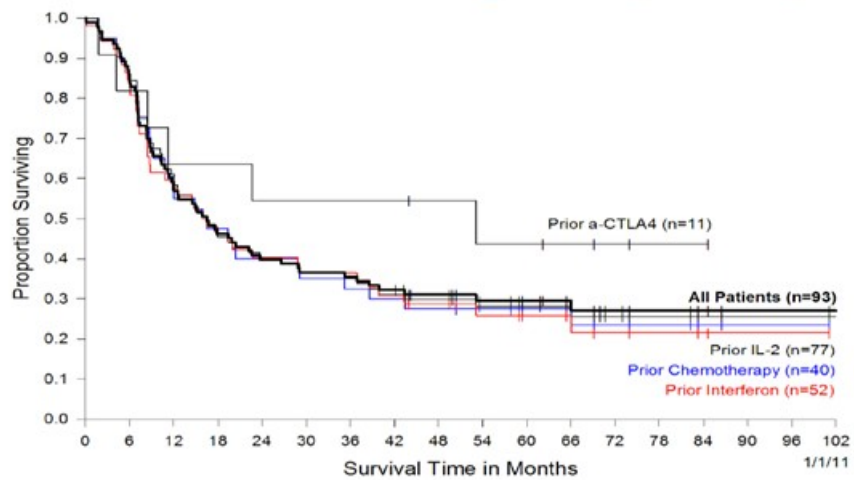

19/20 complete responders are ongoing at 7 to >10 years

Rosenberg, S.A., et al. Durable Complete Responses in Heavily Pretreated Patients with Metastatic Melanoma Using T-Cell Transfer Immunotherapy. *Clinical Cancer Research*, 17(13), 4550-4557.

Lion C-144-01 Study Design

Phase 2, Multicenter, 3-Cohort Study to Assess the Safety and Efficacy of Autologous Tumor Infiltrating Lymphocytes (LN-144) for Treatment of Patients with Metastatic Melanoma

Key Inclusion Criteria:

- Measurable metastatic melanoma and ≥ 1 lesion resectable for TIL generation
- At least one prior line of systemic therapy
- Age ≥ 18
- ECOG PS 0-1

Treatment Cohorts:

1. Non-Cryopreserved LN-144 product
2. Cryopreserved LN-144 product
3. Retreatment with LN-144 for patients without response or who progress after initial response

Endpoints:

- Primary: Safety
- Secondary: Efficacy defined as ORR, CRR, PFS, DOR, and OS

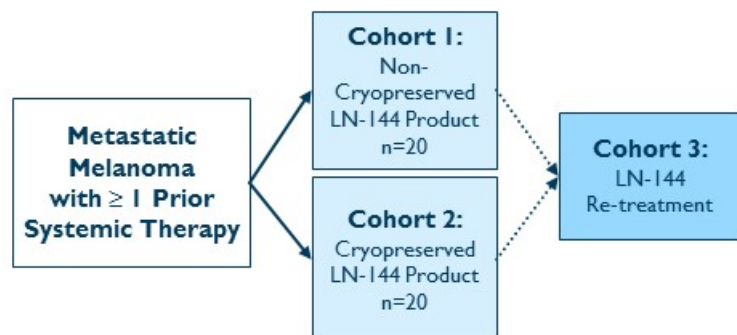

Lion C-144-01 Patient Characteristics

CHARACTERISTIC	N=16, %	CHARACTERISTIC	N=16, %
Gender, n (%)		Baseline ECOG score, n (%)	
Male	7 (43.8)	0	9 (56.3)
Female	9 (56.3)	1	7 (43.8)
Age, n (%)		BRAF Status, n (%)	
Mean (SD)	54.8 (8.44)	Mutated	9 (56.3)
Median	54.5	Wild Type	7 (43.8)
Min, Max	41, 72	Baseline LDH (U/L)	
Prior therapies, n (%)		N (%)	
IL-2	2 (12.5)	1-2 times ULN	7 (43.8%)
anti-CTLA-4	14 (87.5)	> 2 times ULN	1 (6.25%)
anti-PD-1	16 (100.0)	Number of Metastatic Sites at enrollment	
		Median (range)	4 (2-11)
		> 3	64.3%

- Median number of prior therapies: 3 (range: 1-6)
- Median Sum of Diameter for target lesions at Baseline: 10.2 cm
- 81% of patients had Stage IV disease

The patient population was highly refractory to multiple prior lines of therapy, with significant tumor burden at Baseline, and had progressed after at least one checkpoint inhibitor

Lion C-144-01 Safety: Treatment Emergent Serious Adverse Events

PREFERRED TERM	144-01 (N=16)		
	ANY GRADE n (%)	GRADE ≥3 n (%)	GRADE 5 n (%)
Number of subjects reporting at least one Treatment-Emergent SAE	9 (56.3)	9 (56.3)	1 (6.3)
Febrile neutropenia	4 (25.0)	4 (25.0)	0 (0.0)
Pyrexia	1 (6.3)	1 (6.3)	0 (0.0)
Systemic inflammatory response syndrome	1 (6.3)	1 (6.3)	0 (0.0)
Parvovirus B19 infection*	1 (6.3)	1 (6.3)	1 (6.3)
Viral infection	1 (6.3)	1 (6.3)	0 (0.0)
Neutrophil count decreased	3 (18.8)	3 (18.8)	0 (0.0)
Platelet count decreased	3 (18.8)	2 (12.5)	0 (0.0)
Blood bilirubin increased	1 (6.3)	1 (6.3)	0 (0.0)
White blood cell count decreased	1 (6.3)	1 (6.3)	0 (0.0)
Dehydration	1 (6.3)	1 (6.3)	0 (0.0)
Myelodysplastic syndrome	1 (6.3)	1 (6.3)	0 (0.0)
Confusional state	1 (6.3)	1 (6.3)	0 (0.0)
Hypoxia	1 (6.3)	1 (6.3)	0 (0.0)
Hypotension	1 (6.3)	1 (6.3)	0 (0.0)

Treatment Emergent SAEs by PT; * not related to therapy event occurred 6 months after treatment

© 2017, Lion Biotechnologies



Lion C-144-01 Efficacy

- All patients entering the study had received an anti-PD-1 checkpoint inhibitor
- Median number of IL-2 administrations was 6

RESPONSE	PATIENTS, N=14 n (%)
Objective Response Rate	4 (29%)
Disease Control Rate	9 (64%)
Complete Response	1 (7%)
Partial Response	3 (21%)
Stable Disease	5 (36%)
Progressive Disease	4 (29%)
Non-Evaluable*	1 (7%)

* In Efficacy Set 1 of 14 patients was not evaluable due to melanoma-related death prior to first tumor assessment.

Lion C-144-01 Efficacy

- ORR is 29%
- Tumor reduction was seen in 77% of patients representing those who had tumor reduction in the target lesions
- Responses were noted regardless of BRAF mutational status including one long lasting CR (15+ months)

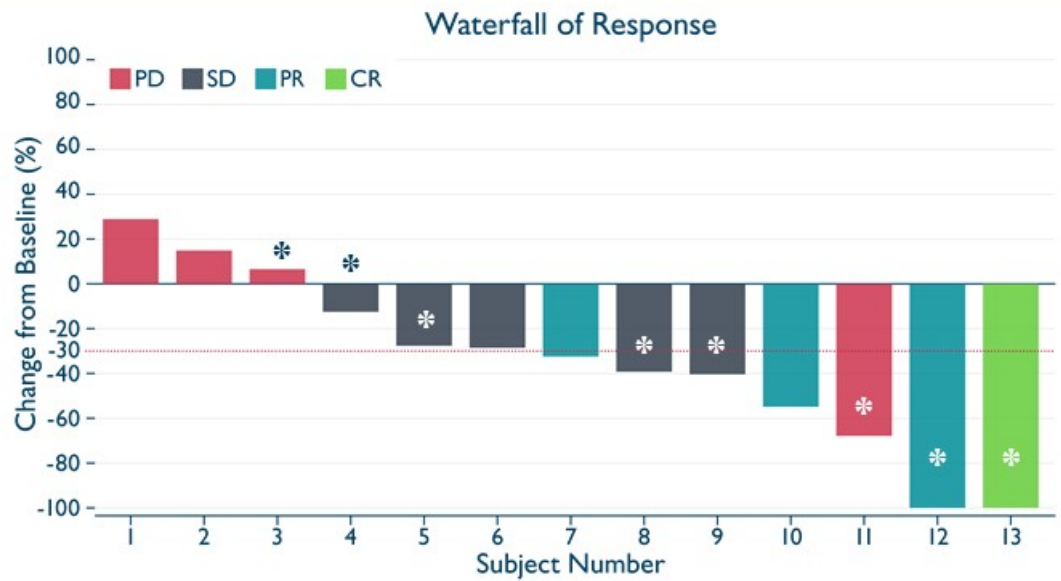

* BRAF mutants

- Of 14 patients in Efficacy Set, one patient was not evaluable due to melanoma-related death prior to first tumor assessment.

- Abbreviations: CR, complete response; PD, progressive disease; PR, partial response; SD, stable disease

Data Cut: 24APR2017

© 2017, Lion Biotechnologies

LION
BIOTECHNOLOGIES

Lion C-144-01 Time to Best Response and Duration

- Mean time to first response: 1.6 months
- Median follow up for this data: 4.1 months

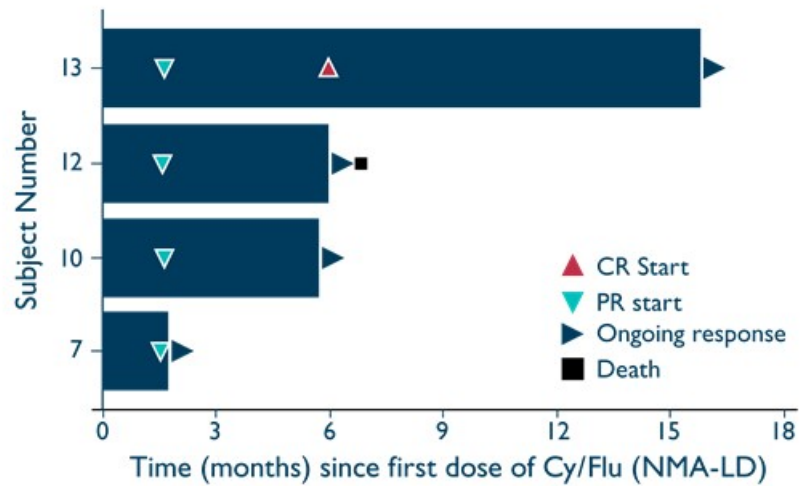

Lion C-144-01 Percent Change in Sum of Diameters

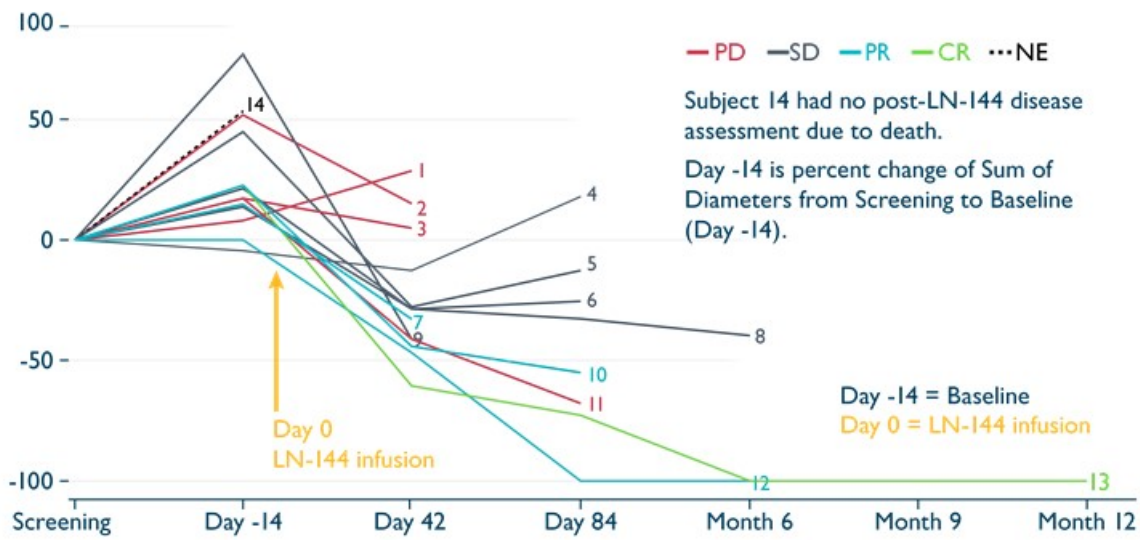

Lion C-144-01 Patient Scan

Patient is in CR

Pre-Treatment



6 weeks Post-Treatment

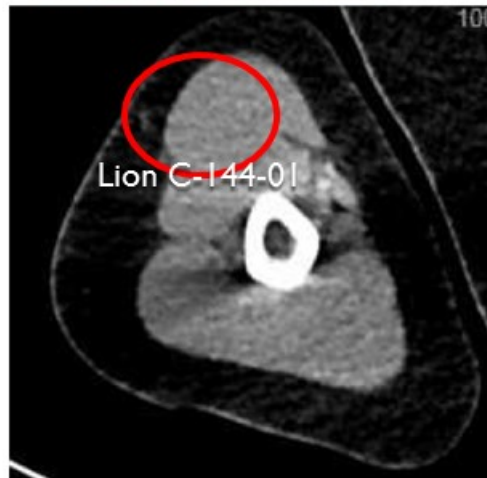

14 months Post Treatment



Lion C-144-01 Phase 2 Trial in Metastatic Melanoma (Upcoming Protocol Amendment)

A Phase 2, Multicenter Study to Assess the Efficacy and Safety of Autologous Tumor Infiltrating Lymphocytes (LN-144) for Treatment of Patients with Malignant Melanoma

Key Inclusion Criteria:

- Measurable metastatic melanoma and ≥ 1 lesion resectable for TIL generation
- At least one prior systemic therapy (anti-PD-1 or BRAF inhibitor (if BRAF mutant))
- Age ≥ 18
- ECOG PS 0-1

Treatment Cohorts:

1. LN-144, non-cryopreserved product
2. LN-144, cryopreserved product
3. Retreatment cohort

Endpoints:

- **Primary: Efficacy** defined as ORR
- **Secondary:** CRR, DCR, PFS, DOR, OR, OS, and Safety

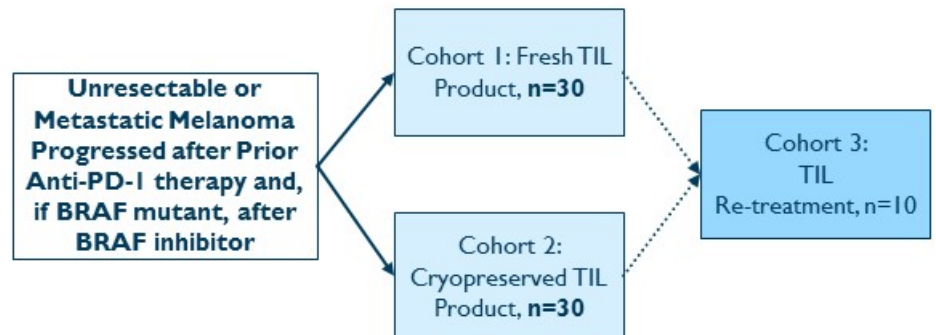

Cervical Cancer

NCI Cervical Cancer and TIL Treatment Data

	PATIENTS (%)	DURATION (MONTHS)
Total	9 (100)	
PR	1 (11)	3
CR	2 (22)	22+, 15+

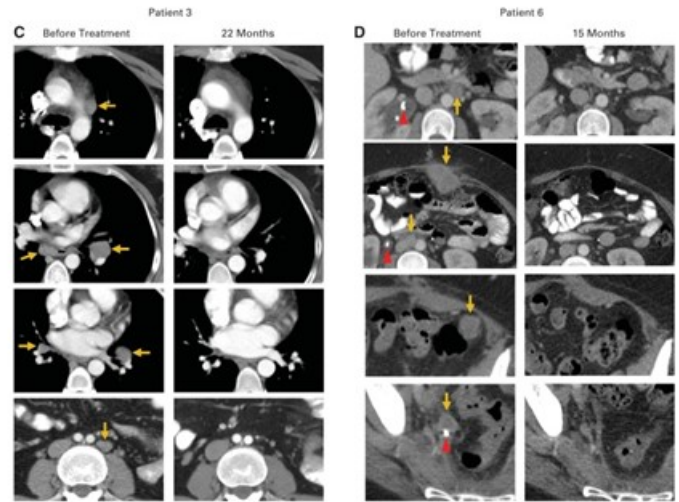

Stevanovic, et al. Complete Regression of Metastatic Cervical Cancer After Treatment with Human Papillomavirus-Targeted Tumor-Infiltrating T Cells. *J Clin Oncol* 2015, 33 (15).
 Hinrichs, et al. HPV-targeted Tumor-Infiltrating Lymphocytes for Cervical Cancer. *J Clin Oncol*, 2014, 23, 5s.

Lion C-145-04 Phase 2 Trial in Recurrent and/or Metastatic Cervical Carcinoma

A Phase 2, Multicenter Study to Evaluate the Efficacy and Safety of Adoptive Cell Therapy Using Autologous Tumor Infiltrating Lymphocytes (LN-145) in Patients with Recurrent, Metastatic or Persistent Cervical Carcinoma

N=47; Simon's two-stage design

LN-145, non-cryopreserved product will be used

Key Inclusion Criteria:

- Measurable metastatic disease and ≥ 1 lesion resectable for TIL generation
- At least one prior systemic therapy
- Age ≥ 18
- ECOG PS 0-1

Endpoints:

- Efficacy and Safety

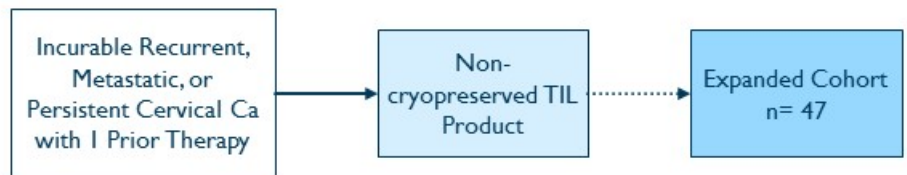

Head and Neck Cancer

Lion C-145-03 Phase 2 Trial in Recurrent and/or Metastatic Squamous Cell Carcinoma of the Head and Neck

A Phase 2 Study to Evaluate the Safety, Tolerability and Efficacy of Cell Transfer Therapy Using Autologous Tumor Infiltrating Lymphocytes (LN-145) followed by IL-2 in Patients with Recurrent and/or Metastatic Squamous Cell Carcinoma of the Head and Neck

N=47; Simon's two-stage design

Key Inclusion Criteria:

- Measurable metastatic disease and ≥ 1 lesion resectable for TIL generation
- At least one prior systemic therapy
- Age ≥ 18
- ECOG PS 0-1

Endpoints:

- Safety and Efficacy

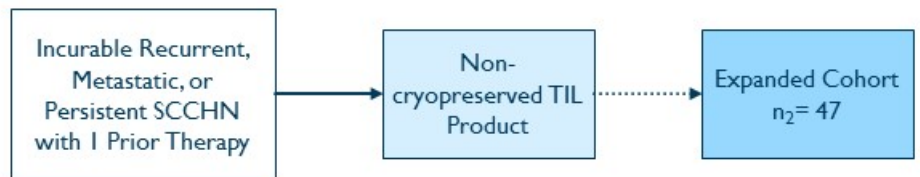

TIL Market Opportunity

Market Opportunity for TIL Therapy in US

- Lion's lead indication for TIL is metastatic melanoma:
 - Prevalence of melanoma in US (2014) is greater than 1.17 million cases
 - 74% percent of new cases each year occur in patients 20-74 years old (1)
 - Metastatic (regional and distant) melanoma patients compose 13% of all new cases ~10,000 cases

Melanoma and Other Potential Indications for TIL Therapy

INDICATION	NEW CASES ⁽²⁾	DEATHS ⁽²⁾
Melanoma	87,110	9,730
Cervix Uteri	12,820	4,210
Oral Cavity & Pharynx	49,670	9,700
Lung & Bronchus	222,500	155,870
Bladder	79,030	16,870
Breast	252,710	40,610
Pancreatic	53,670	43,090
Brain & Other Nervous System	23,800	16,700

⁽¹⁾ Source: <http://seer.cancer.gov/statfacts/> SEER 18 2007-2013.

⁽²⁾ Source: <http://seer.cancer.gov/statfacts/> | Estimates for 2017.

Competitive Advantages of TILs in Solid Tumors

TILs target a diverse array of cancer antigens; this approach represents a highly differentiated, customized and targeted immunotherapy

CHECKPOINTS	TCR	CAR	TIL
Utility in several solid tumors	Few solid tumors treated so far	No examples of utility in solid tumors	Utility in melanoma and HPV cancers
Long maintenance period	One-time treatment	One-time treatment	One-time treatment
No genetic modification	Genetic modification	Genetic modification	No genetic modification
Long-term irreversible toxicities	Potential on-target, off-tissue effects	Potentially immunogenic: cytokine release syndrome	Minimal chance of unpredicted on-target, off-tissue effects
Target multiple tumor antigens	Target only single tumor antigen	Target only single/surface tumor antigen	Target multiple tumor antigens
Off-the-shelf	Autologous	Autologous	Autologous
No HLA restriction	HLA restriction	No HLA restriction	No HLA restriction

Ongoing and Future Directions

- Continuous improvement in process development
 - Shortening of the process further
 - Automation
- Evaluation of biomarkers for response
- Selected TILs, modifying the properties may offer benefits
 - Selection of more specific TIL (Select for PD-1, 4-1BB Expression)



Financials

Financial Summary

As of March 31, 2017	(IN MILLIONS)
Common shares outstanding	62.4
Preferred shares	8.8
Warrants/options/RSU's	13.8
Cash	\$147.2
Debt	\$0

Anticipated 2017 Key Milestones

MANUFACTURING

- ✓ Reduce manufacturing cycle from 5-6 weeks to ~3.5 weeks
- ✓ Complete tech transfer and ramp volumes at WuXi AppTec and H. Lee Moffitt Cancer Center and Research Institute
- ✓ Continue working with Lonza
- ✓ Expand capacity into additional CMOs
 - ✓ *PharmaCell (EU)*
- Continue efforts to reduce manufacturing cycle time and manufacturing costs

CLINICAL

- Complete enrollment in ongoing Phase 2 melanoma clinical trial
 - ✓ *Study expanded*
- ✓ Release interim clinical data at an upcoming scientific forums
- ✓ Initiate Phase 2 clinical trials in head & neck and cervical cancers
- Support Karolinska University Hospital in initiating two Phase I clinical trials in pancreatic and glioblastoma cancers

REGULATORY

- Define the regulatory pathway for LN-144 melanoma drug candidate in U.S.
- Initiate regulatory interactions with ex-U.S. health authorities
 - ✓ *Discussions initiated*

PARTNERSHIPS

- Evaluate potential opportunistic partnerships in alignment with our core competencies
 - ✓ *MDA*

The logo features the word "LION" in a dark blue, serif font. The letter "O" is replaced by a stylized green and blue circular graphic. Below "LION" is the word "BIOTECHNOLOGIES" in a green, sans-serif font.

LION
BIOTECHNOLOGIES

LEADERSHIP & INNOVATION IN ONCOLOGY

Thank you

© 2017, Lion Biotechnologies

MDACC TIL Manufacturing Process

Total Processing Time approx. 5-6 weeks



© 2017, Lion Biotechnologies

LION
BIOTECHNOLOGIES

Clinical Regressions in Late-Stage Disease

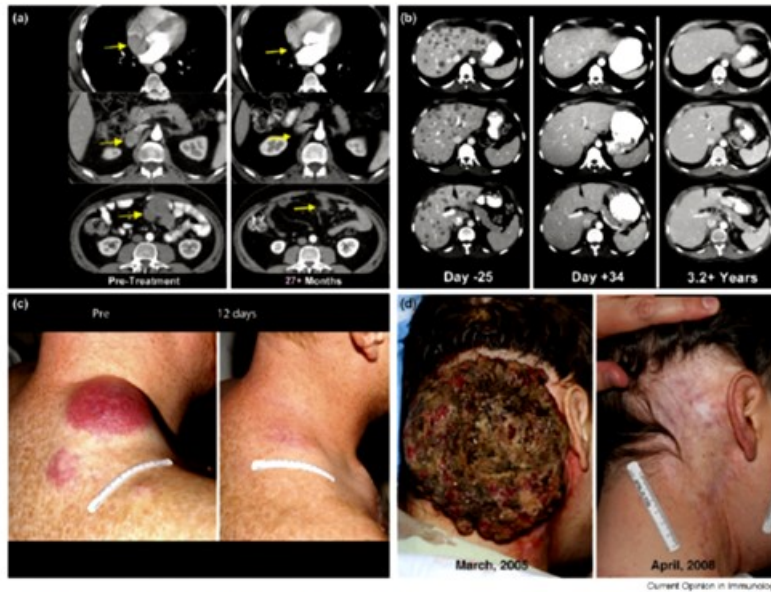

Rosenberg, S.A. et al. (2009, April). Adoptive Cell Therapy for the Treatment of Patients with Metastatic Melanoma. *Current Opinion in Immunology*, 21(2), 233-240.

Compelling Results in Late-Stage Disease

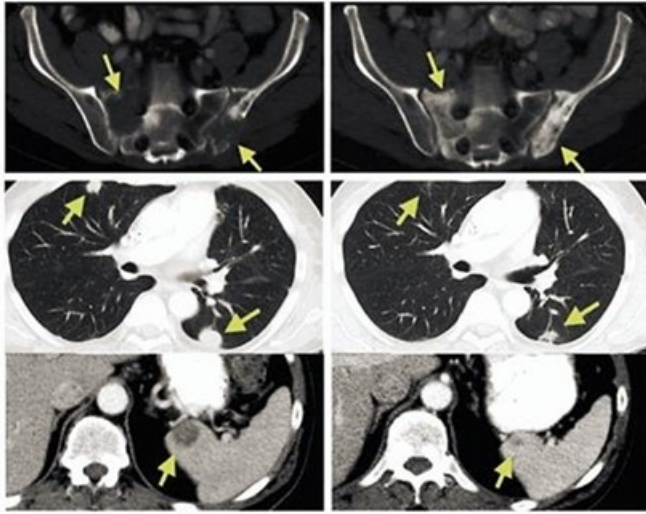

Pretreatment

2 months posttreatment



Day -9

Day +11

Day +76

Dudley, M. E., et al. (2010, December). CD8 Enriched "Young" Tumor Infiltrating Lymphocytes Can Mediate Regression of Metastatic Melanoma. *Clinical Cancer Research*, 16(24), 6122-6131.